

**10' STANDARD  
SET UP INSTRUCTIONS**

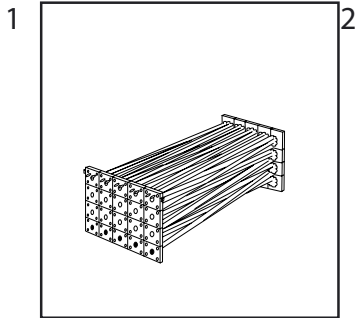

1 Remove frame from case and place on floor. Stand in front of unit with the yellow dots on bottom and facing you. Grasp upper ends of frame and pull up and outward.

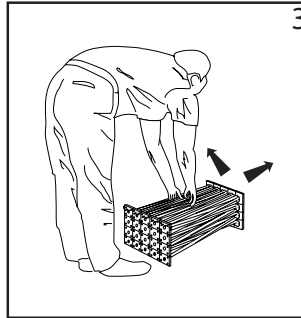

2 Continue pulling up and outward until the frame is fully expanded. Spacer bars should be close enough to each other to allow for a connection.

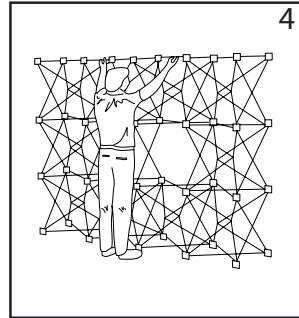

3 Frame should pop into a fully open and upright position. Yellow dots on bottom row of hubs should be on the floor.

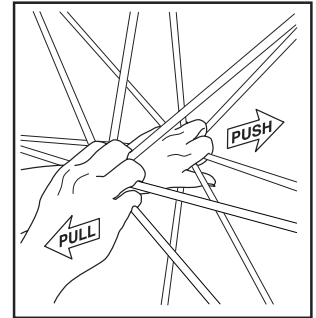

4 To close the frame, push and pull from the middle of the frame while grasping the hubs as shown. Once the frame starts to collapse, move hands away from the hubs to avoid pinching. Do not pull tubing alone.

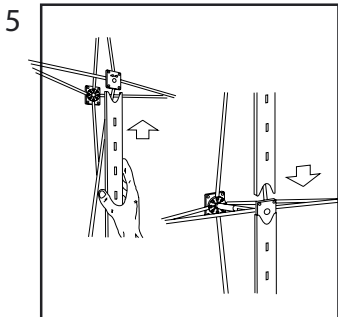

5 Begin at the bottom center module and attach channel bars by sliding up onto the top hub. Line up the bottom of the channel bar over the lower hub and slide down to secure. Leave the top front row open for top channel bars.

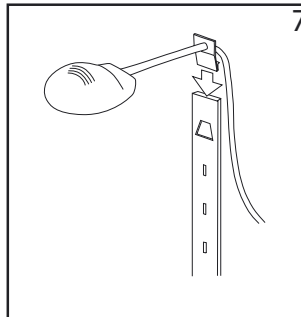

6 Locate top channel bars. With channel facing away from you, attach lights to top channel bars by inserting light bracket into slot on top of bar.

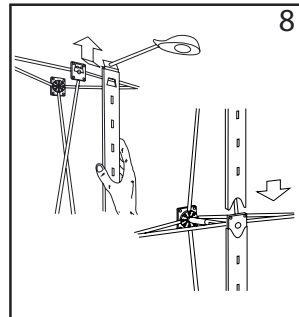

7 Mount top channel bars (with lights attached) to frame by aligning hole in channel bar over panel pegs on top hub and sliding up. Once top of channel bar is in place, slide channel bar down onto bottom hub to secure.

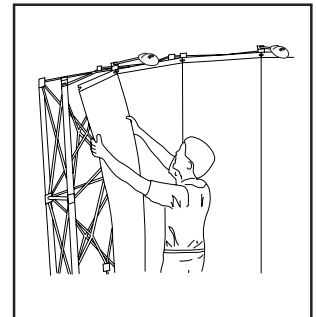

8 Hold a front panel on its side edges about 1/3 of the way down from the top. Lift section and guide notches over the panel pegs on the top hubs. Slowly release the panel, allowing it to roll down the channel bars. Repeat for all front panels aligning them as you go.

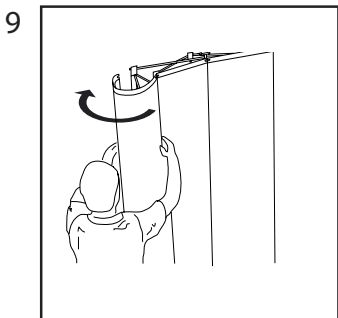

9 Lift end panel and guide front notch of plastic plate over front peg. Hook the other side on the panel peg at the back of the frame.

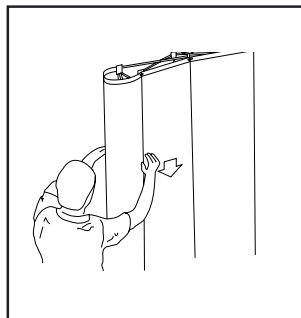

10 Slowly run your hands down the sides of the panel, attaching magnetic strips to the channel bars and straightening as you go.

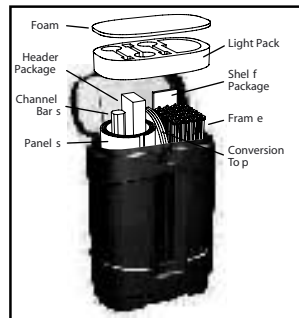

11 To pack case, first roll up panels w/fabric (graphic) surface to inside and insert into left side of case. Slide counter top sections into center of case to act as a divider. Insert collapsed frame into right side of case. Place accessories as shown.

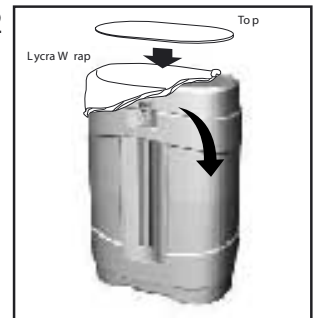

12 To convert the empty case into a counter, stretch the Lycra skirt over the case as shown and pull down to conceal the case. Place the counter top onto the wrapped case attaching it to the Velcro on the surface.